

115

110

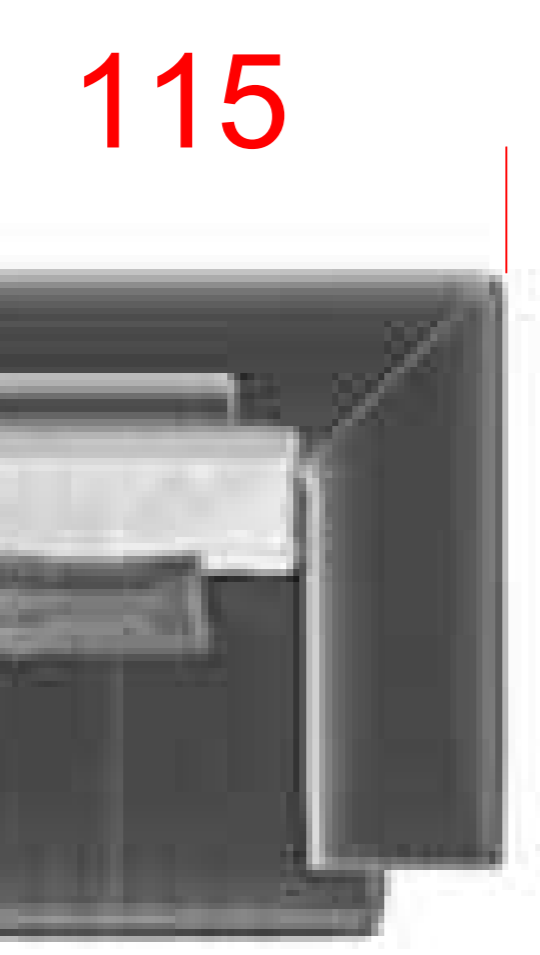

115



90

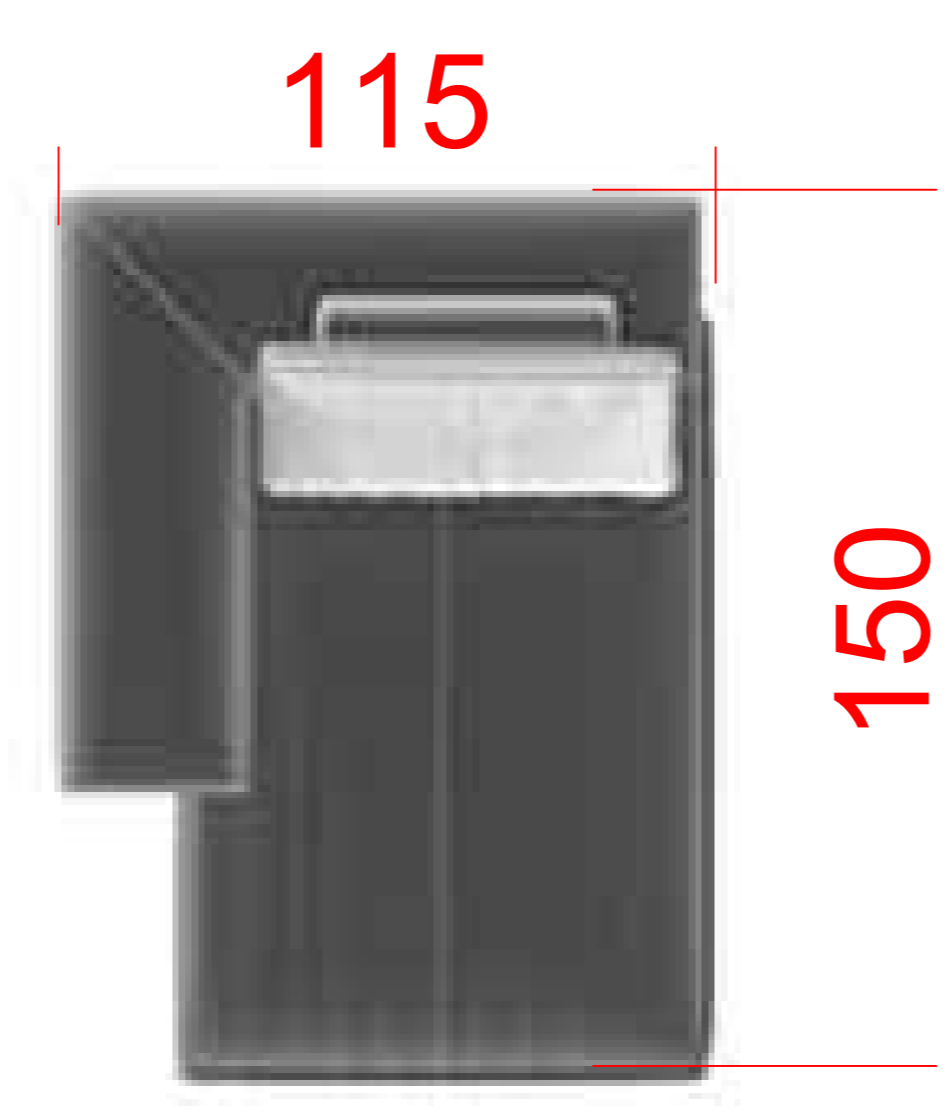

115

150



115

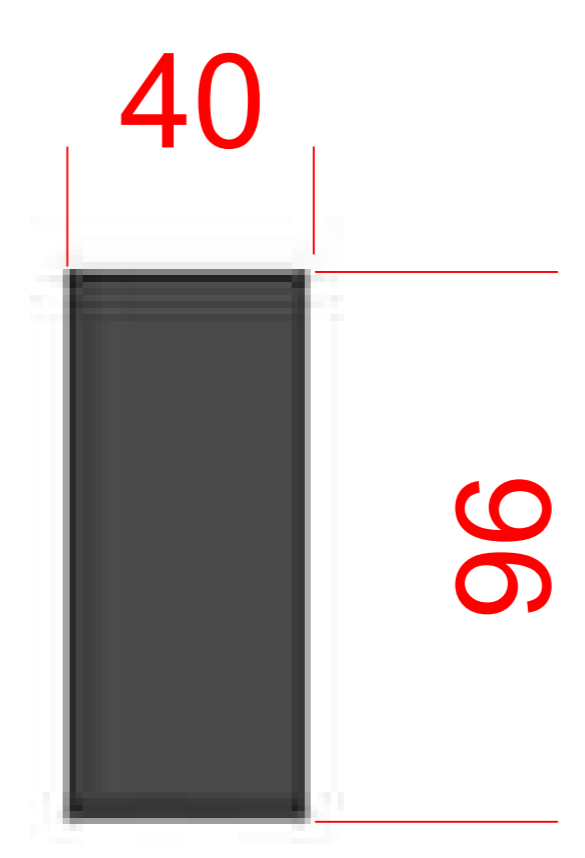

40

96

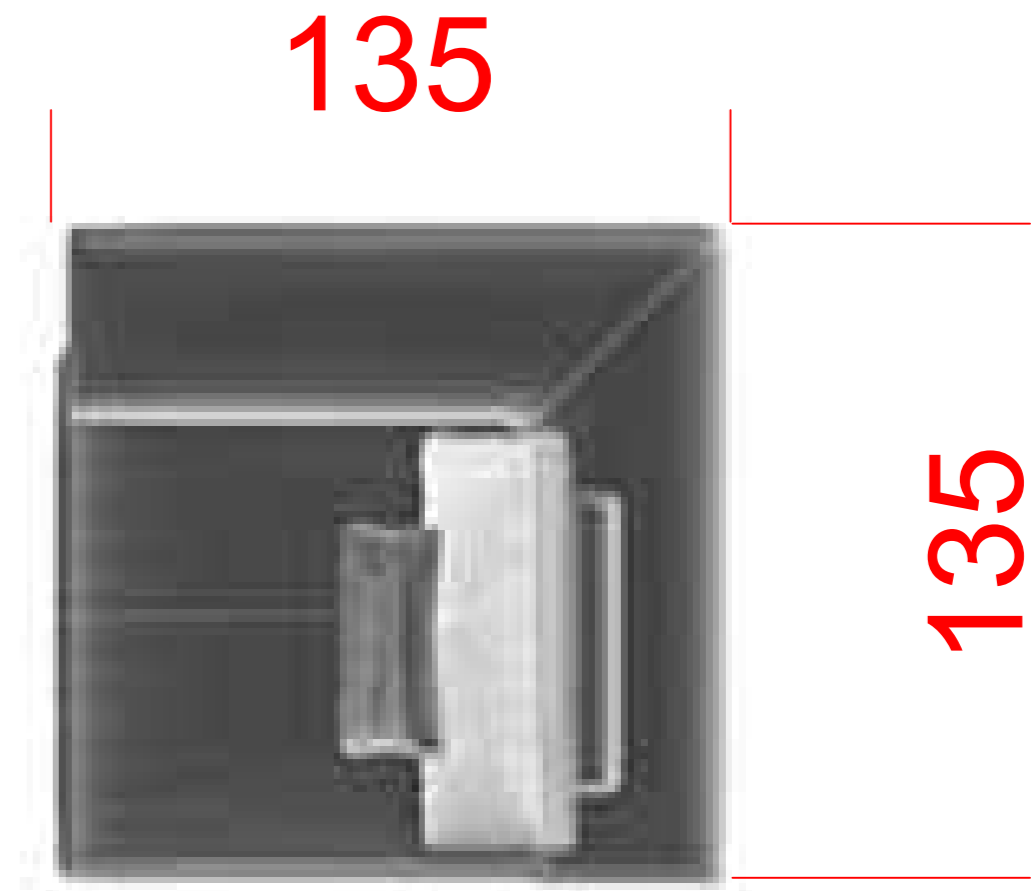

135

135

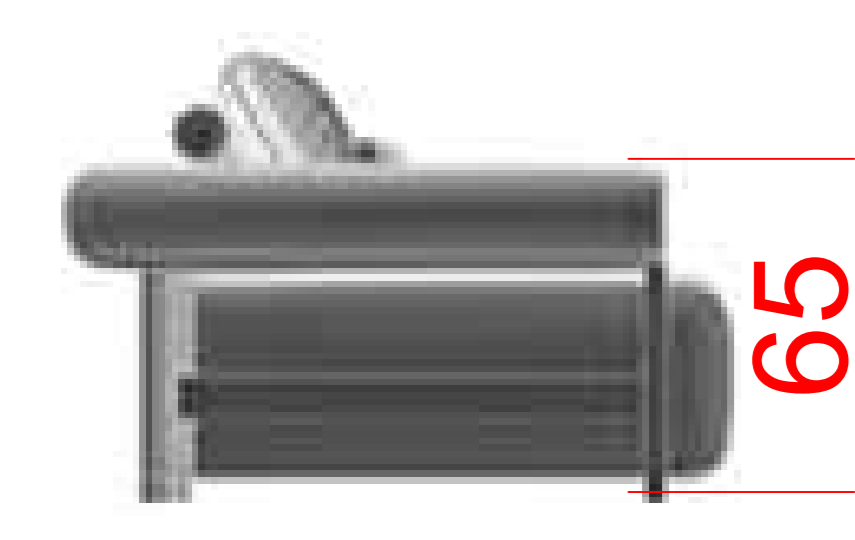

65

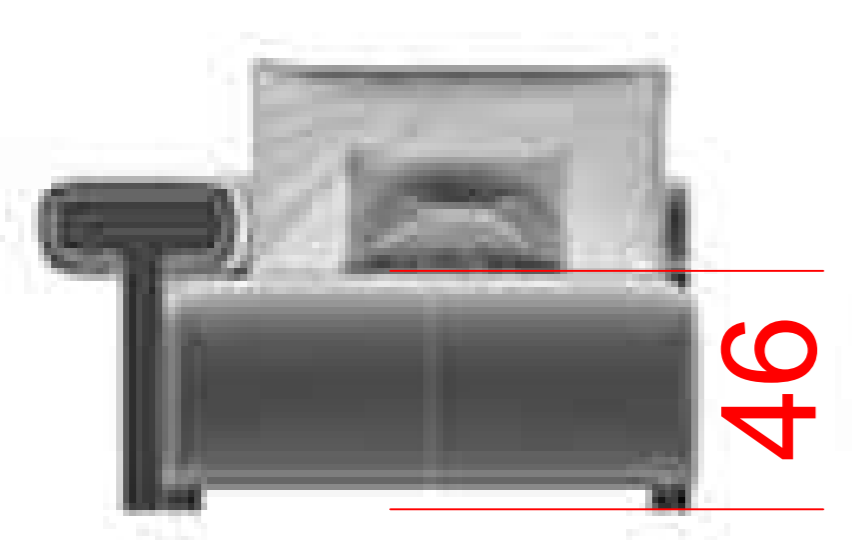

46

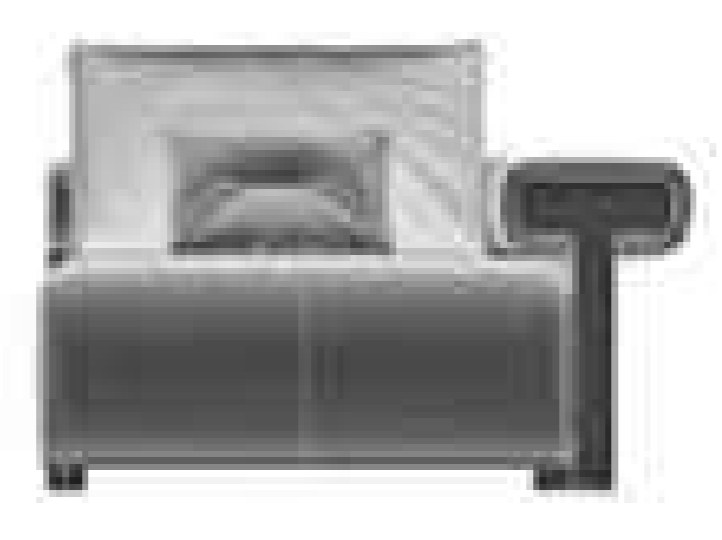

T3

T4

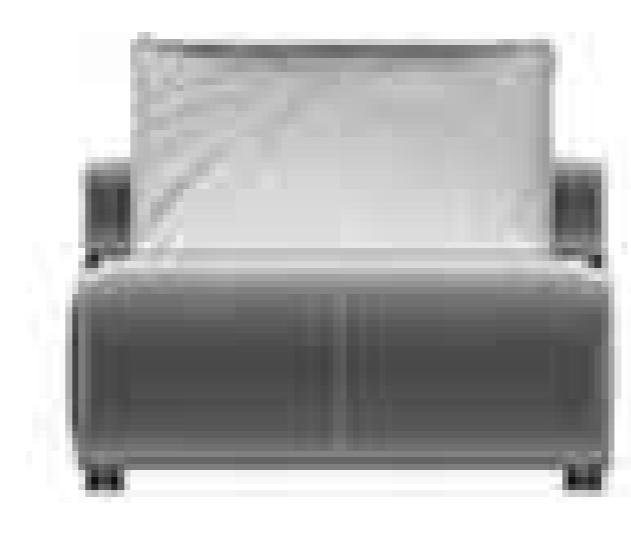

T1

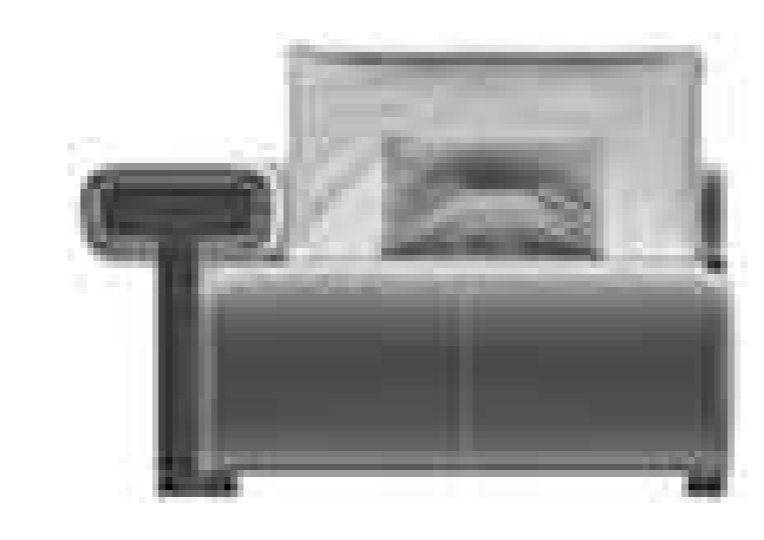

T5

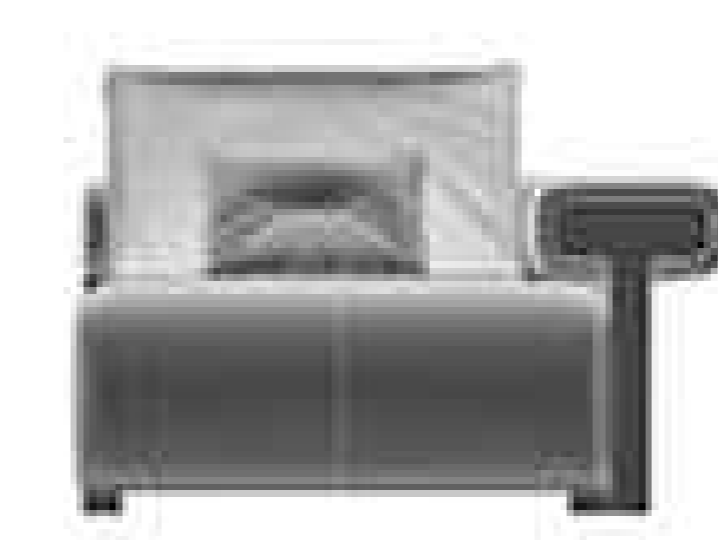

T6



35

T8

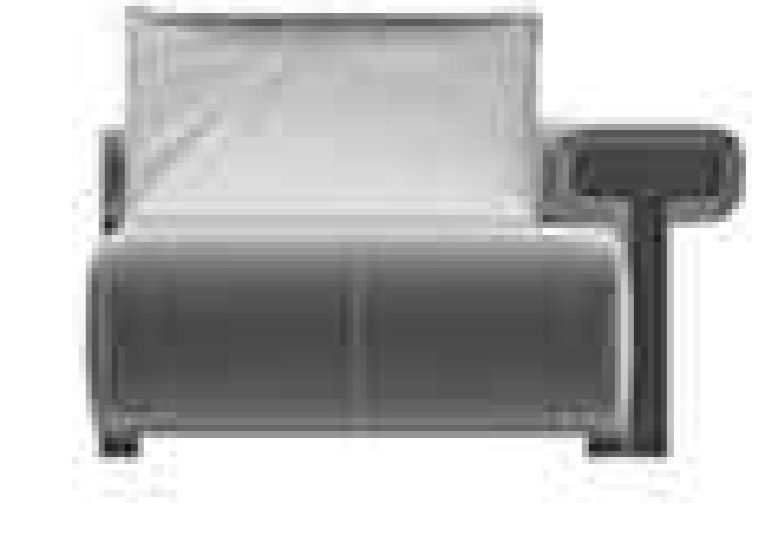

T7

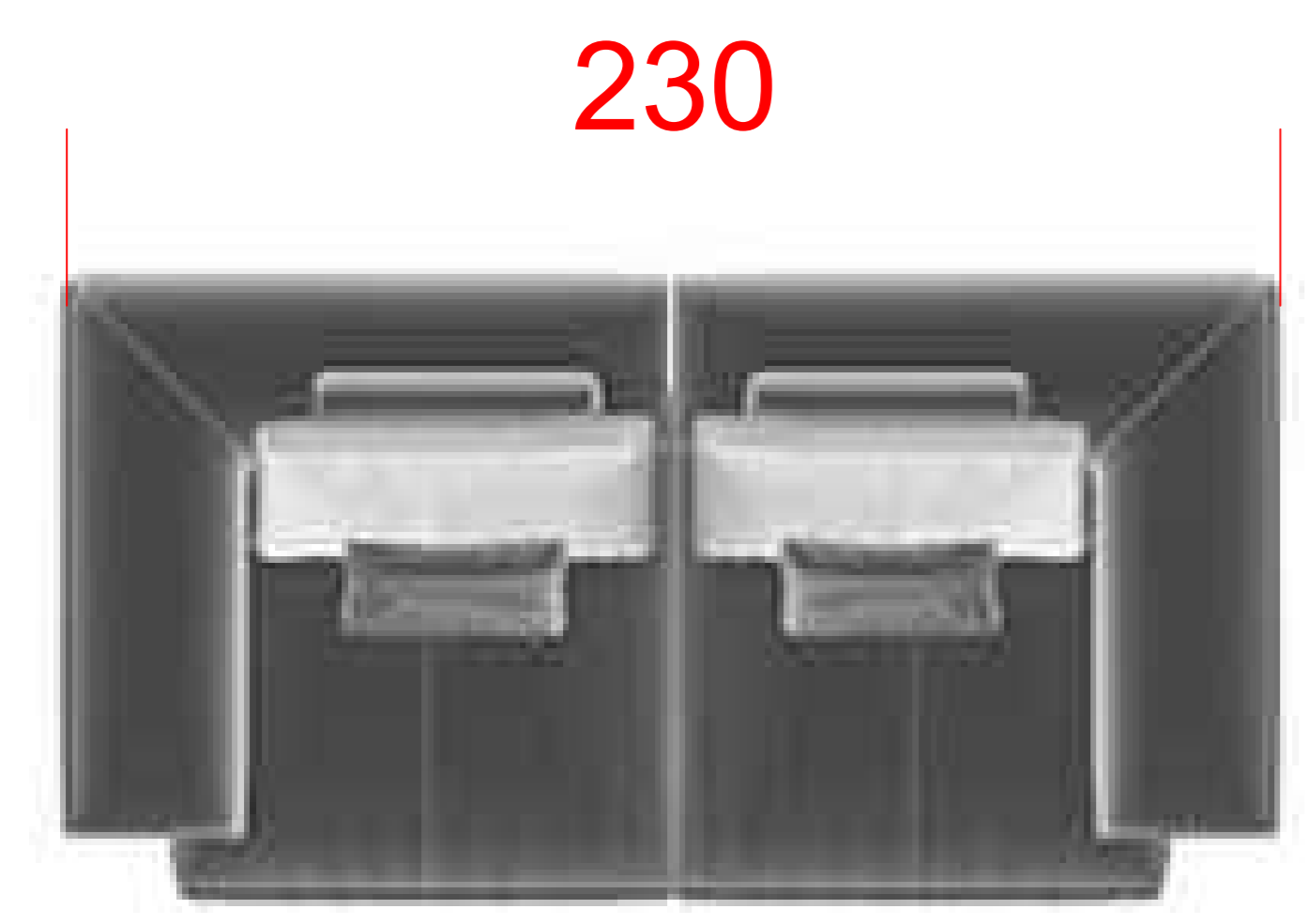

230

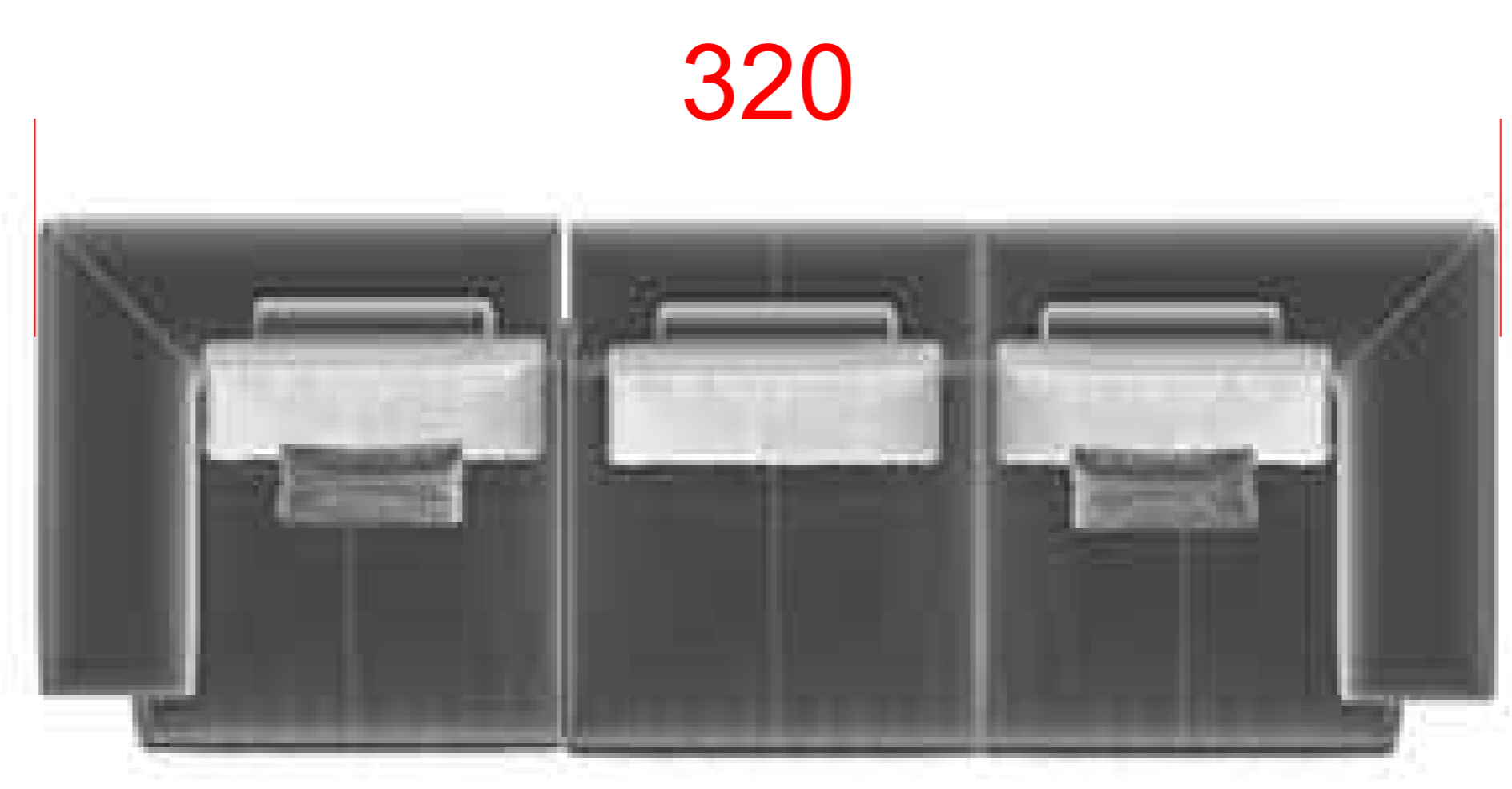

320

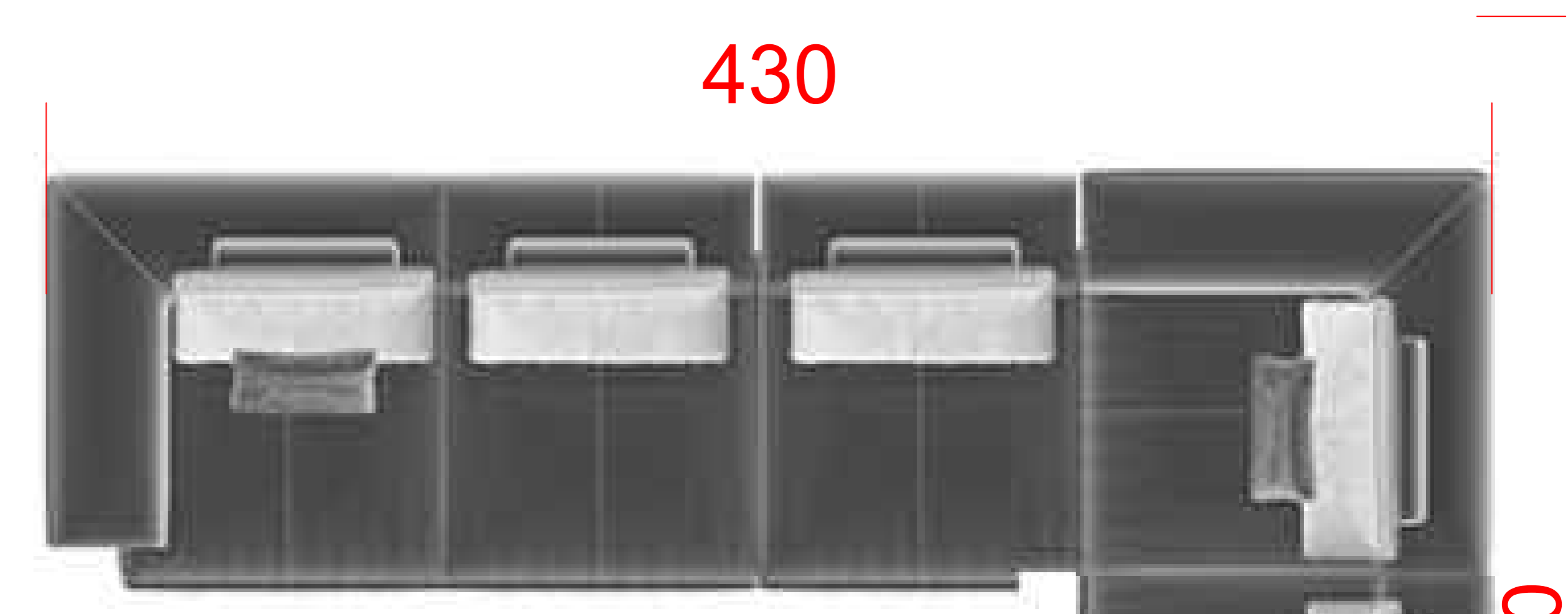

430

380



270

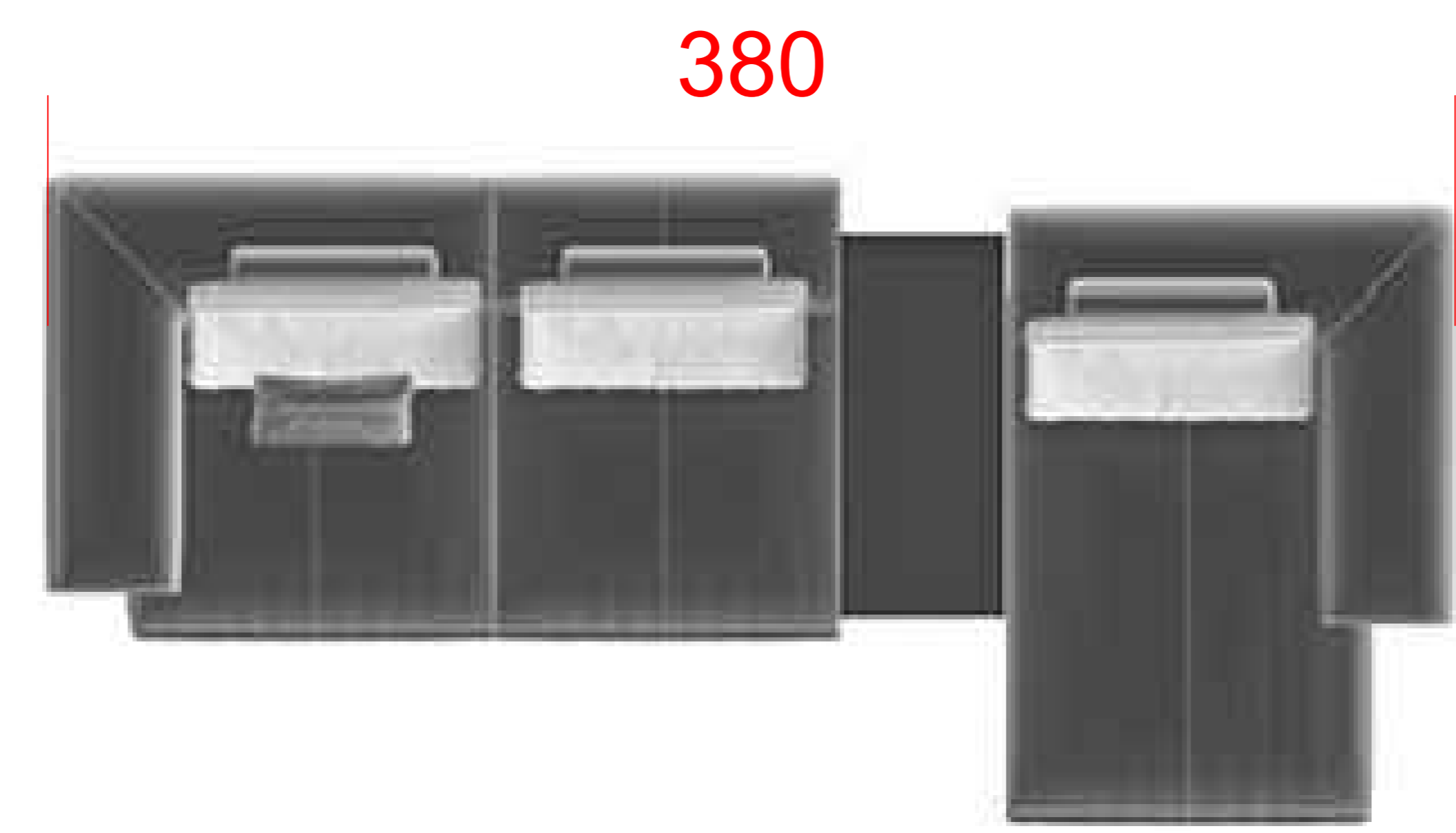

380



380

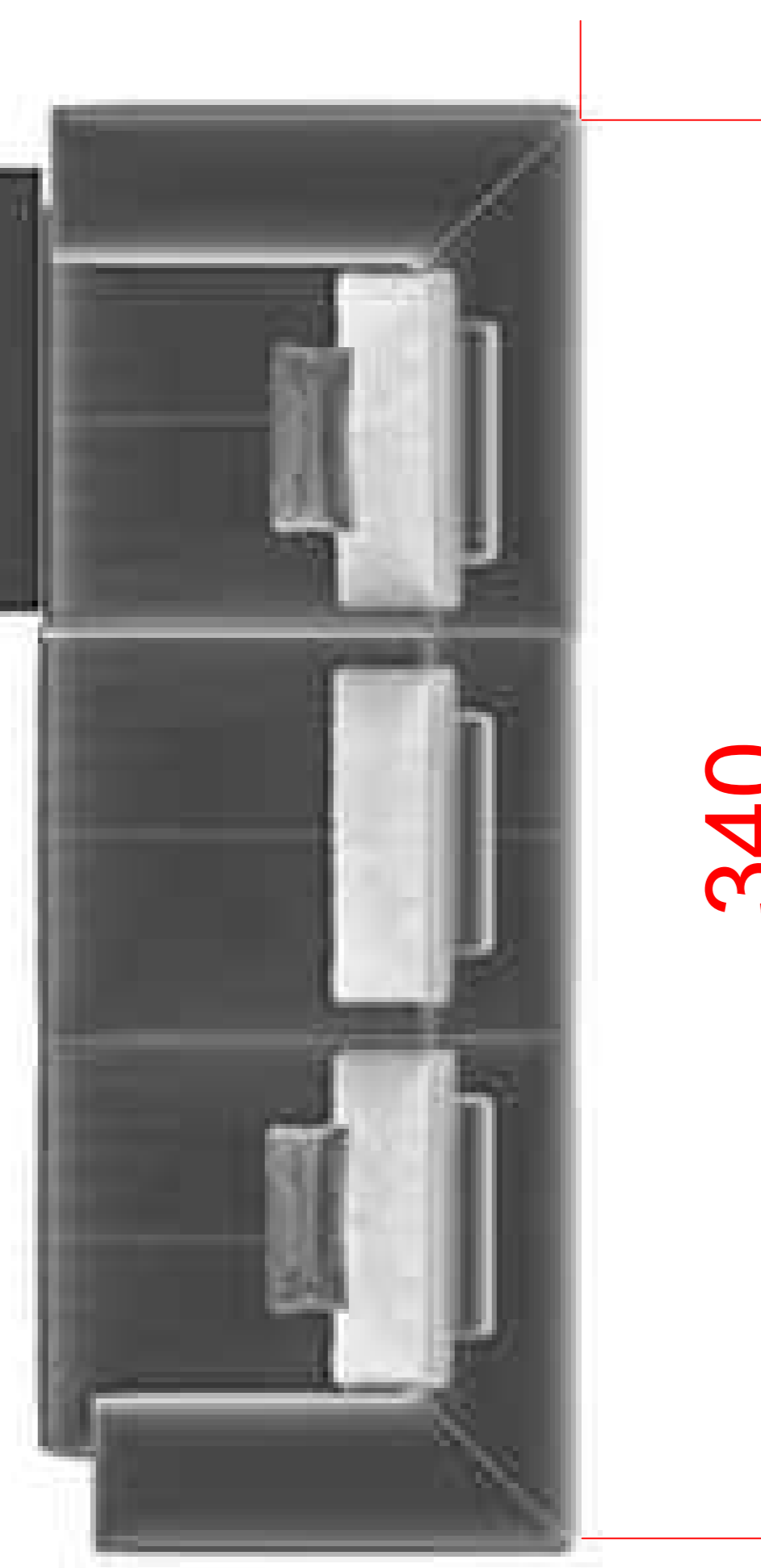

340

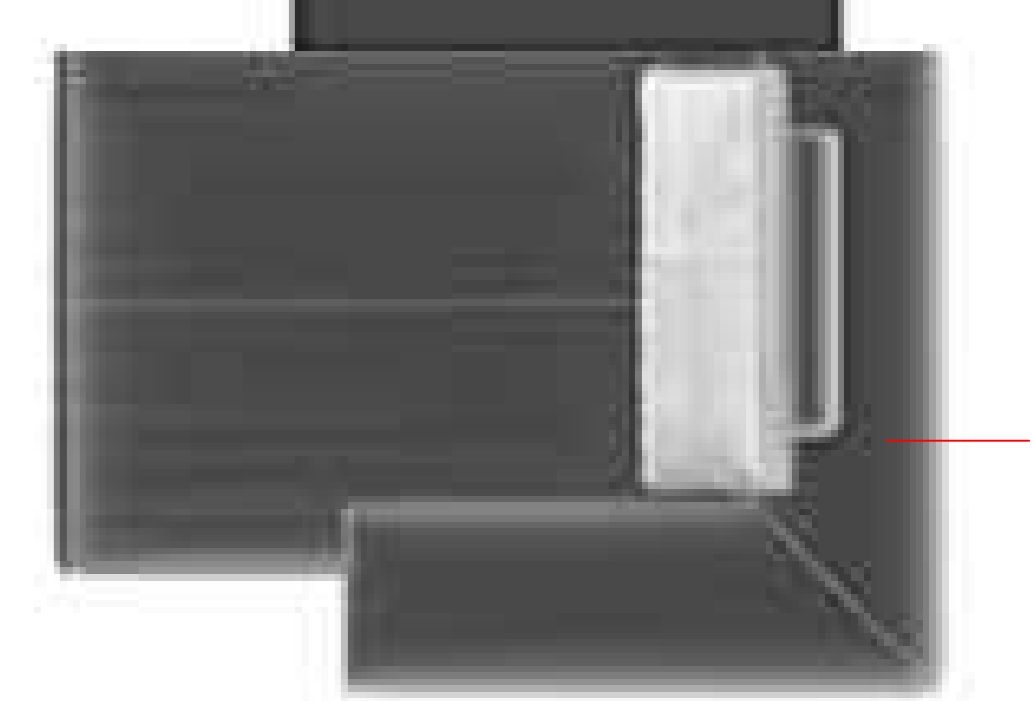

380